



# PRODUCT SPECIFICATIONS

## Preliminary Specification

**Module No: VISLCD-104IA36A01**

**PRODUCT TYPE: TFT MODULE**

**VERSION: A0**

**Huayuan:**

APPROVED BY	CHECKED BY	DESIGNED BY
		Jiang

**Customer:**

APPROVED BY	TESTED BY	INSPECTION RESULT



## Record of Revision

Vieta Group copyright 2021  
All right reserved, Copying forbidden.

Version	Revise Date	Page	Content
V02	2021.08.11	Page	Add backlight parameter



## Table of Contents

1. FEATURES .....	4
2. GENERAL SPECIFICATIONS .....	4
3. PIN DESCRIPTION .....	5
3.1 Connector .....	5
3.2 PIN assignment .....	5
4. ABSOLUTE MAXIMUM RATING .....	7
5. DC CHARACTERISTICS .....	8
5.1 Parameter .....	8
5.2 BL power output.....	8
5.3 Power sequence.....	9
6. LVDS SIGNAL TIMING CHARACTERISTICS .....	10
6.1AC Electrical characteristics.....	10
6.2 Input clock and data timing diagram.....	10
6.3 DC electrical characteristics .....	11
6.4 Data timing .....	12
6.5 LVDS data input format .....	12
7. OPTICAL CHARACTERISTICS .....	14
7.1 Optical specification.....	14
8. QUALITY ASSURANCE .....	17
9. PRECAUTIONS .....	18
9.1 ESD (Electrical Static Discharge) strategy.....	18
9.2 Environment .....	18
9.3 Assembly and handling precautions.....	18
9.4 Safety precautions .....	20
9.5 Others .....	20
10. MECHANICAL DRAWING .....	21
11. Packaging Drawing.....	22



## 1. FEATURES

104IA36A01 is a transmissive type color active matrix liquid crystal display (LCD), which uses amorphous thin film transistor (TFT) as switching devices. This panel has a 10.4 inches diagonally measured active display area with resolution 1024 x 768. This product is composed of a TFT LCD panel, polarizers, driver ICs, FPC and PCBA.

## 2. GENERAL SPECIFICATIONS

Item	Description	Unit
Display Size	10.4	inch
Display Type	Transmissive, a-Si	-
Active Area (HxV)	210.432 (H) x 157.824 (V)	mm
Number of Dots (HxV)	1024 x RGB x 768	dot
Pixel Pitch(HxV)	0.2055 x 0.2055	mm
Color Arrangement	RGB Stripe	-
Color Numbers	256K/16.7 M	-
Outline Dimension (HxVxD)	238.6 (H) x 175.8 (V) x6.5 (D)	mm
NTSC (CIE1931) (Under C light)	60 (Typ.)	%
White Point (x,y) (Under C light)	x:0.318,y: 0.366(Typ.)	
Response Time	≤30	ms
Viewing Angle (Light On) (R/U/L/D)	CR≥ 10 @ R/L/U/D(80°/80°/80°/80°) (Typ.)	
Surface Treatment	HC	
Contrast Ratio (Light On)	1000:1 (Typ)	
Operation Temperature	-20~70	°C
Storage Temperature	-30~80	°C
Interface	LVDS	
Weight	400	g
Panel power consumption	Max:1.4W @white pattern	W

### 3. PIN DESCRIPTION

#### 3.1 Connector

There are 3 connectors on PCBA, location & Pin1 is showed on below figure.

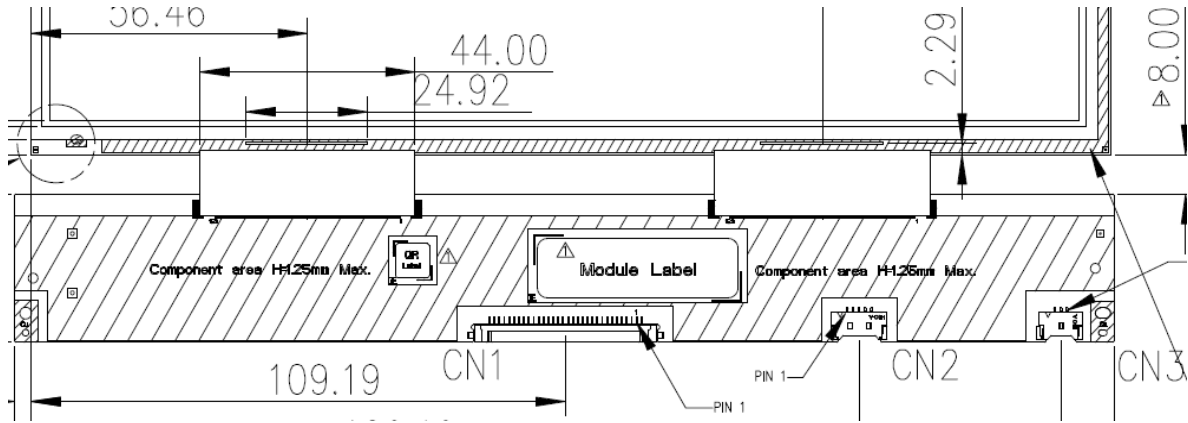

Connectors' type:

1. CN1 : Input LVDS CONN,30pins, P-two , 187098-30091
2. CN2: Input BL power CONN,5pins, Cillux,CI4205M2HRD-NH
3. CN3: Output BL power CONN, 3pins, Cillux,CI4203M2HRD-NH

#### 3.2 PIN assignment

##### 3.2.1 Connector 1 :

A 30pin connector of P-two 187098-30091 is used for the module electronics interface. And a special plug needed for connecting this connector, the recommended model is P-two 187130-30xx or JAE FI-X30H.

No	Symbol	I/O	Function	Remark
1	NC	I	Reserved as BIST function for INX test	1
2	GND	P	Ground	
3	Rin3+	I	Positive LVDS differential data input (+)	
4	Rin3-	I	Negative LVDS differential data input (-)	
5	GND	P	Ground	
6	CLK+	I	Clock signal (+)	
7	CLK-	I	Clock signal (-)	
8	GND	P	Ground	
9	Rin2+	I	Positive LVDS differential data input (+)	
10	Rin2-	I	Negative LVDS differential data input (-)	
11	GND	P	Ground	
12	Rin1+	I	Positive LVDS differential data input (+)	
13	Rin1-	I	Negative LVDS differential data input (-)	

14	GND	P	Ground	
15	Rin0+	I	Positive LVDS differential data input (+)	
16	Rin0-	I	Negative LVDS differential data input (-)	
17	GND	P	Ground	
18	NC	-	No Connection	
19	GND	P	Ground	
20	SEL6/8	I	Selection for 6 bits/8bit LVDS data input Low or NC : 8 bit input mode High : 6 bit input mode	2
21	NC	I	Reversed as EE_WP for OTP function	3
22	NC	I	Reversed as EE_SDA for OTP function	3
23	NC	I	Reversed as EE_SCL for OTP function	3
24	Reverse	I	Reverse panel function (Display rotation)	4
25	GND	P	Ground	
26	GND	P	Ground	
27	GND	P	Ground	
28	VDD	P	Power supply: + 3.3V	
29	VDD	P	Power supply: + 3.3V	
30	VDD	P	Power supply: + 3.3V	

Note:

1. Pin1 is reversed as BIST function for test, don't connect signal to this pin, keep floating.
2. SEL6/8 is used for selecting 6bit/8bit LVDS data input, L or NC: 8bit; High:6bit.
3. Pin21,22,23 are used as SPI interface for OTP function, don't connect any signal to these pin, and don't short them, keep floating.
4. Reverse pin is used for selecting scanning direction.

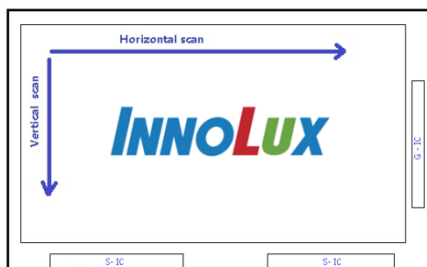

Fig. 1 Normal scan (Pin24, Reverse = Low or NC)



Fig. 2 Reverse scan (Pin24, Reverse = High)



### 3.2.2 Connector 2: Cillux,CI4205M2HRD-NH

5-pin connector is used for input power & control signals for BL converter power IC

No	Symbol	I/O	Function	Remark
1	LED_VCCS	P	12V input	
2	LED_VCCS	P	12V input	
3	GND	P	Ground	
4	LED_PWM	I	PWM	
5	LED_EN	I	Converter power IC Enable (Active High)	

## 4. ABSOLUTE MAXIMUM RATING

Item	Symbol	Min.	Max.	Unit	Remark
Power Supply Voltage	VDD	-0.3	3.6	V	
	LED_VCCS	-0.3	25	V	
Storage temperature	Tstg	-30	+80	°C	
Operating Temperature	Topr	-20	+70	°C	

Note:

- (1) All of the voltages listed above are with respect to GND= 0V
- (2) Device is subject to be damaged permanently if stresses beyond those absolute maximum ratings listed above.



## 5. DC CHARACTERISTICS

### 5.1 Parameter

Item	Symbol	Values			Unit	Remark
		Min.	Typ.	Max.		
Power voltage	VDD	3.0	3.3	3.6	V	
	LED_VCCS	11	12	13	V	
Input logic high voltage	V <sub>IH</sub>	3.0	3.3	3.6	V	1
Input logic low voltage	V <sub>IL</sub>	0	-	0.5	V	
Current for Power	I <sub>VDD</sub>	-	250	-	mA	V <sub>CC</sub> =3.3V at 60 HZ, all White
	I <sub>LED_VCCS</sub>	-	0.52	-	A	
LED_EN Control Level	BL On	3.0	-	5	V	
	BL Off	0	-	0.3	V	
LED_PWM Control Level	PWM High Level	3.0	-	5	V	
	PWM Low Level	0	-	0.3	V	
LED_PWM Control Frequency	f <sub>PWM</sub>	1K	-	20K	Hz	2

(GND=0V, T<sub>A</sub>=25 °C)

Note 1: Including signal: SEL6/8 & Reverse Note 2: LED\_PWM duty >10%.

### 5.2 BL power output

Item	Symbol	Values			Unit	Remark
		Min.	Typ.	Max.		
Voltage for LED backlight	LED+	31	33	35	V	1
Current for LED backlight	LED1-/LED2-	78	80	82	mA	2

Note 1: output power LED+ OVP is 40V.

~~Note 2: Set BL feedback 2 channels, each channel feedback current is 80mA~~

地址：深圳市宝安区大洋路中粮(福安)机器人智造产业园 15 栋 4 楼(南区) 电话：0755-2732 5127 传真：0755-2721 1112

工厂：湖南省株洲市天元区新马西路 329 号中南高科 A9 栋

电话：0731-2866 0283 传真：0731-2886 0280



LED life time	-	20,000	-	-	Hr	2
---------------	---	--------	---	---	----	---

## 5.2 Power Sequence

The power sequence specifications are shown as the following table and diagram.

Symbol	Value		Unit
	Min.	Max.	
$t_1$	1	20	ms
$t_2$	10	50	ms
$t_3$	200	500	ms
$t_4$	200	500	ms
$t_5$	50	200	ms
$t_6$	0	20	ms
$t_7$	500	-	ms
$t_A$	0	50	ms
$t_B$	0	50	ms

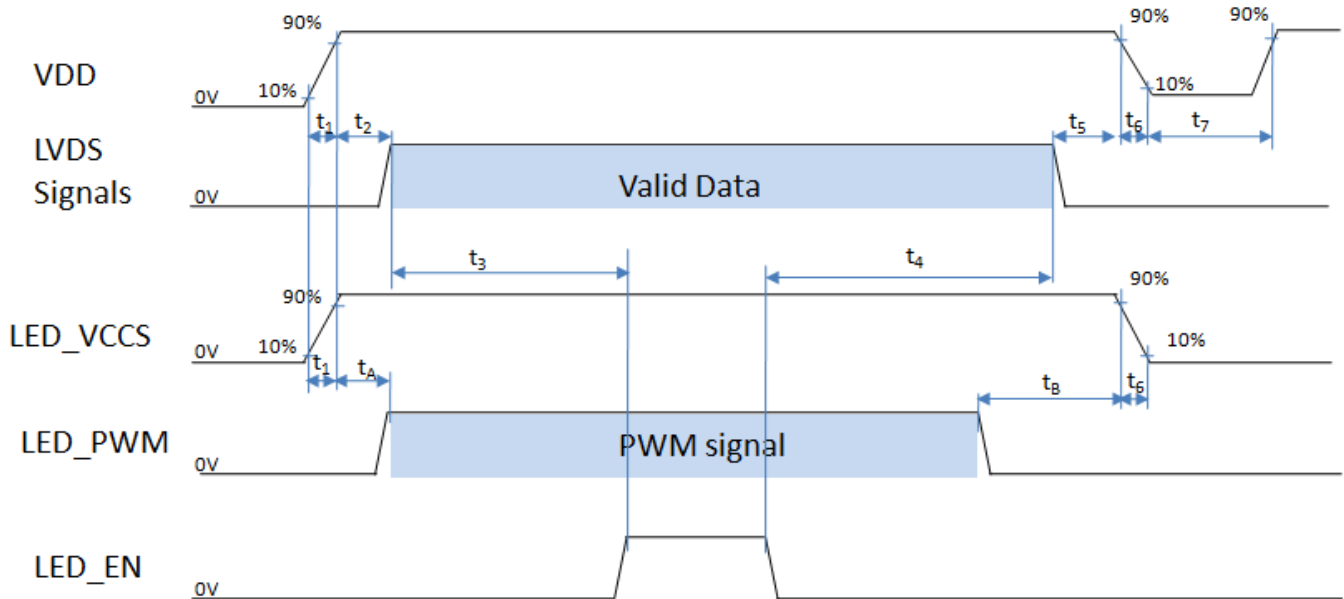

Note 1: Please don't plug the interface cable of on when system is turned on.

Note 2: Please avoid floating state of the interface signal during signal invalid period.

Note 3: It is recommended that the backlight power must be turned on after the power supply for LCD and the interface signal is valid.

## 6. LVDS SIGNAL TIMING CHARACTERISTICS

### 6.1AC Electrical Characteristics

Parameter	Symbol	Min	Typ	Max	Unit	Condition
Clock frequency	RxFCLK	26.2	51.2	71	MHz	
Input data skew margin	TRSKM	500	500	$1/(2 \times RxFCLK)$	ps	Typical value for 1024*600 resolution
Clock high time	TLVCH		$4/(7 \times RxFCLK)$		ns	$ VID =400\text{mv}$ $RxVCM=1.2\text{V}$ $RxFCLK=71\text{MHz}$ $VDD\_LVDS=3.3\text{V}$
Clock low time	TLVCL		$3/(7 \times RxFCLK)$		ns	
VSD setup time	TenPLL	0	TenPLL	150	us	

### 6.2 Input Clock and Data Timing Diagram

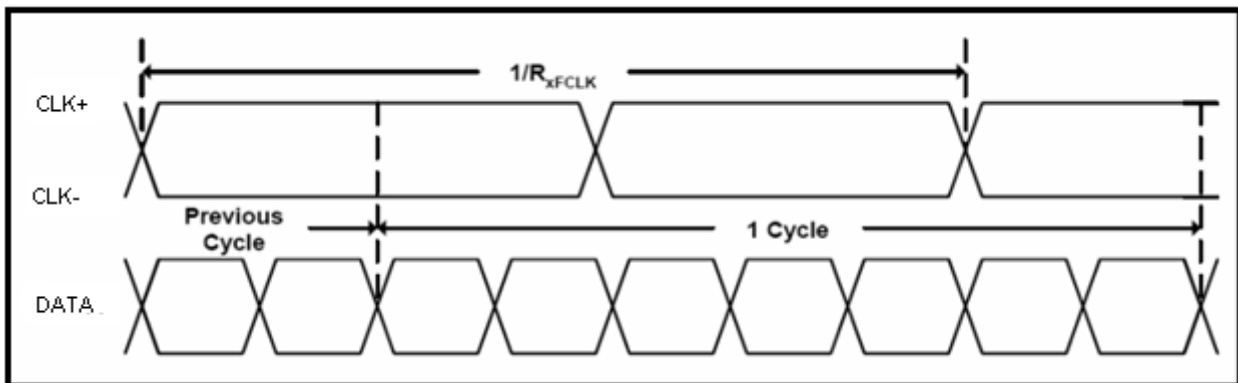

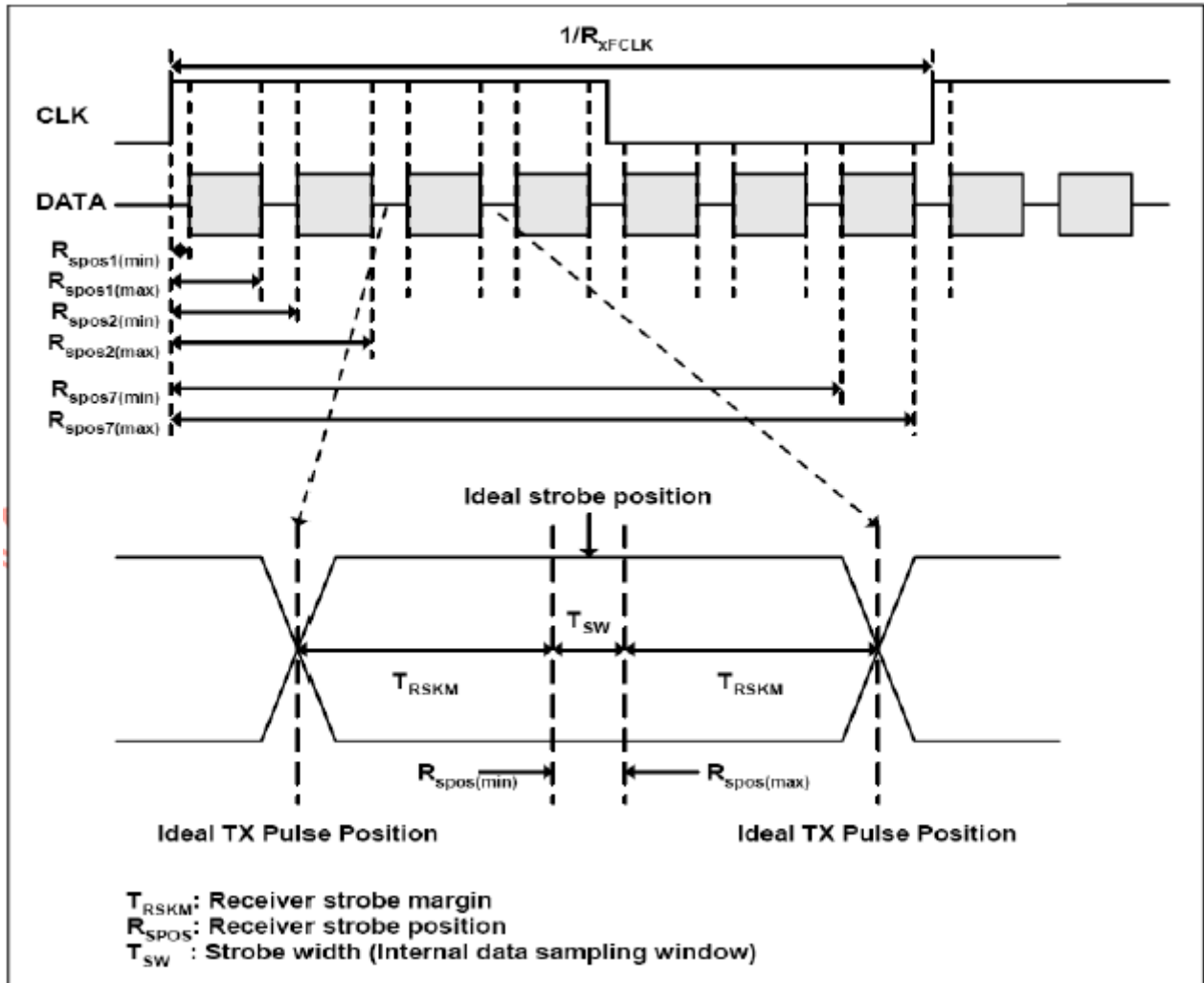

### 6.3 DC Electrical Characteristics

Parameter	Symbol	Values			Unit	Remark
		Min.	Typ.	Max.		
LVDS Differential input high Threshold voltage	$R_{xVTH}$	-	-	+100	mV	$R_{xVCM}=1.2V$
LVDS Differential input low Threshold voltage	$R_{xVTL}$	-100	-	-	mV	
Input Voltage range (Singled-end)	$R_{xVIN}$	0	-	$VDD-1.2+$ $ V_{ID} /2$	V	
LVDS Differential input common mode voltage	$R_{xVCM}$	$ V_{ID} /2$	-	$VDD-1.2$	V	
LVDS Differential voltage	$ V_{ID} $	0.2	-	0.6	V	

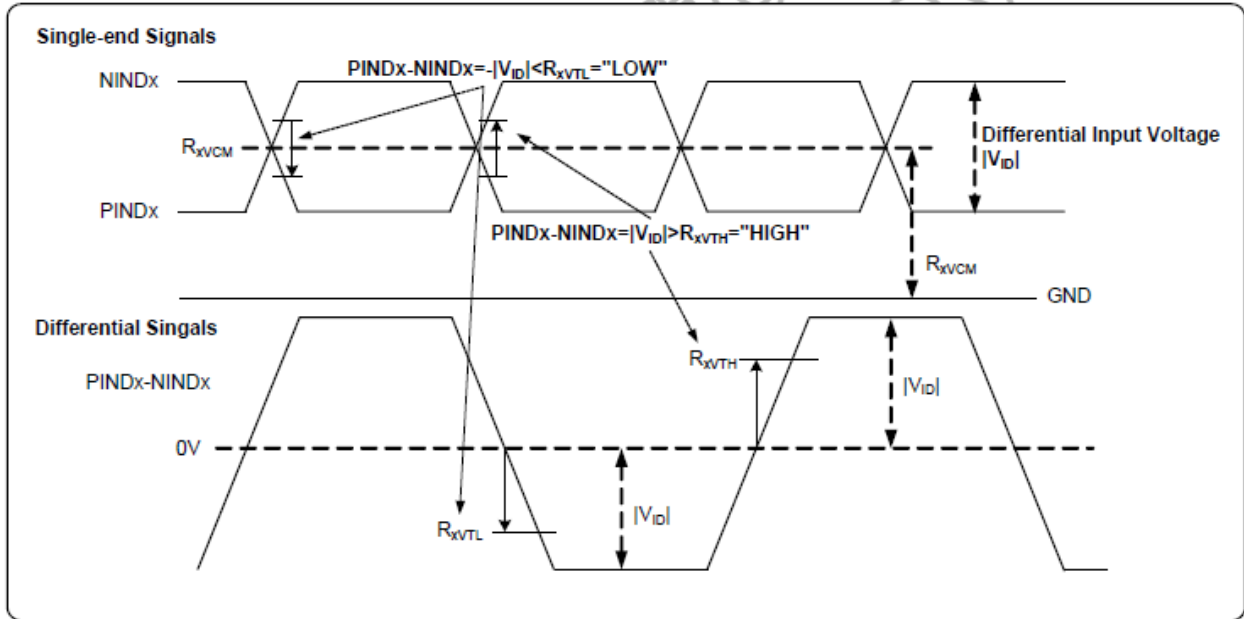

## 6.4 Data Timing

Parameter	Symbol	Spec.			Unit
		Min.	Typ.	Max.	
DCLK frequency	fclk	52	65	71	MHz
Horizontal display area	thd	1024			DCLK
HSD period	th	1114	1344	1400	DCLK
HSD blanking	thb+thfp	90	320	376	DCLK
Vertical display area	tvd	768			$T_H$
VSD period	tv	778	806	845	$T_H$
VSD blanking	tvbp+tvfp	10	38	77	$T_H$

## 6.5 LVDS Data Input Format

SEL6/8 = "High" for 6 bits LVDS Input

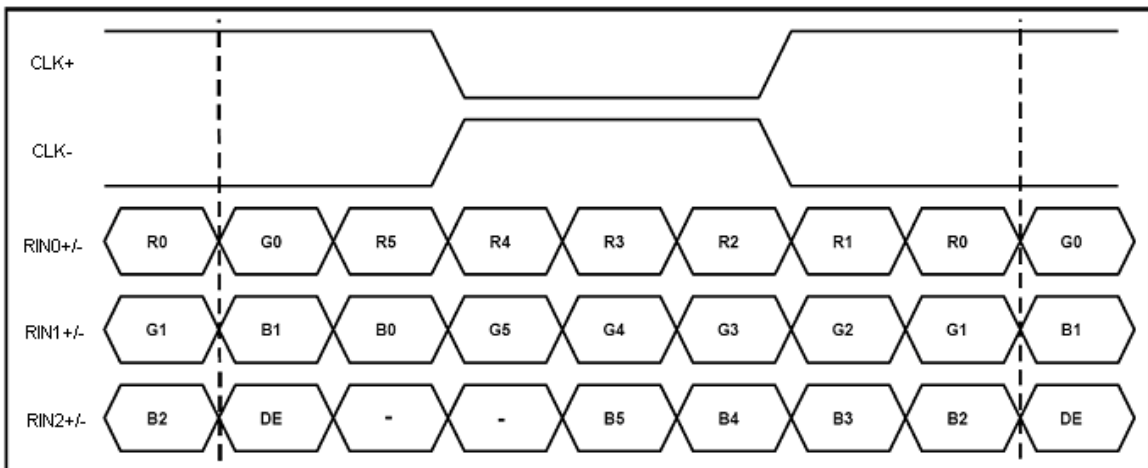

SEL6/8 = "Low" or "NC" for 8 bits LVDS Input

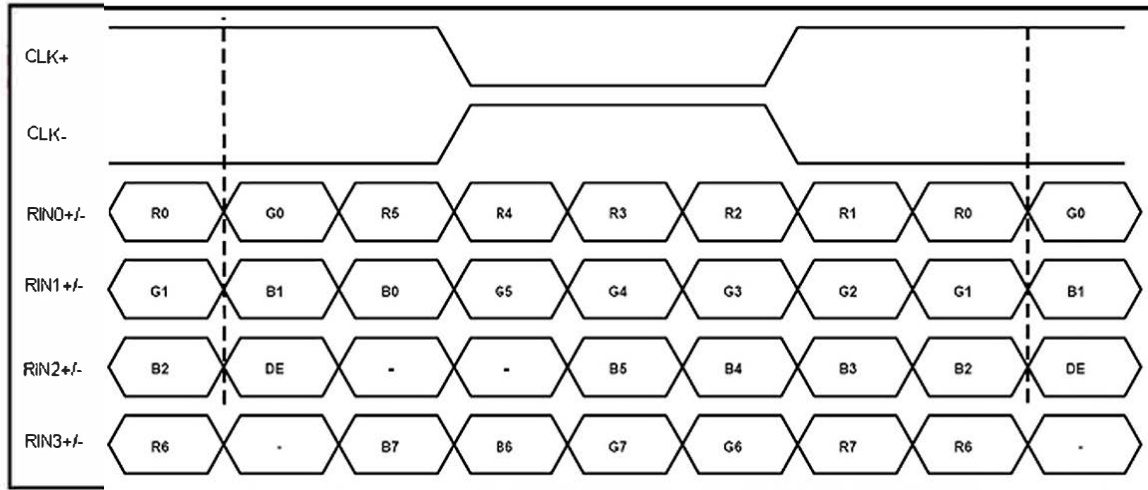

## 7. OPTICAL CHARACTERISTICS

### 7.1 Optical Specification

The relative measurement methods of optical characteristics are shown

Item	Symbol	Condition	Min.	Typ.	Max.	Unit	Note					
Color Chromaticity (CIE 1931) FOG Only with C-light	Red	Rx	Typ - 0.03	0.651	Typ + 0.03	-	C Light Source (1),(5) (6),(7),(8)					
		Ry		0.332								
	Green	Gx		0.288								
		Gy		0.564								
	Blue	Bx		0.138								
		By		0.125								
	White	Wx		0.31								
		Wy		0.30								
	Color gamut	C.G						55	61.2	-	%	
	luminance	cd/ m <sup>2</sup>						500	600	-	%	VIETE BLU
Life time	H		30000	50000			(1),(4),(6)					
Contrast Ratio	CR		800	1000	-	-	(2)					
Response Time	T <sub>R+T<sub>F</sub></sub>	$\theta_x=0^\circ, \theta_y=0^\circ$	-	25	35	ms	(3),(6)					
Viewing Angle	Horizontal	x +	CR ≥ 10	80	-	-	Deg.	(1),(5),(6)				
		x -		80	-	-						
	Vertical	y +		80	-	-						
		y -		80	-	-						

Note (1) Definition of Viewing Angle ( $\theta_x, \theta_y$ ):

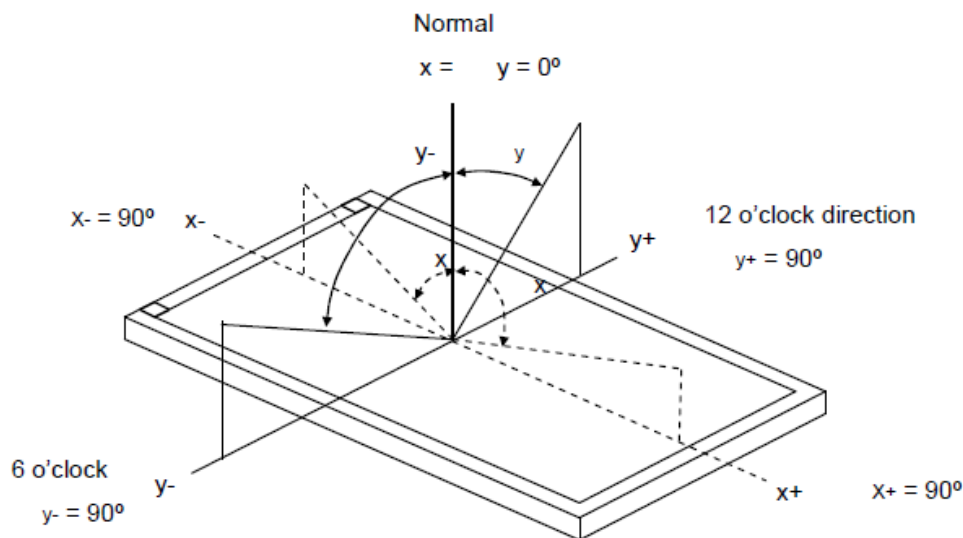

Note (2) Definition of Contrast Ratio (CR):

The contrast ratio can be calculated by the following expression.

$$\text{Contrast Ratio (CR)} = L_{255} / L_0$$

L255: Luminance of gray level 255

L 0: Luminance of gray level 0

CR = CR (5)

CR (X) is corresponding to the Contrast Ratio of the point X at Figure in Note (6).

Note (3) Definition of Response Time :

The response time is defined as the LCD optical switching time interval between “White” state and “Black” state. Rise time ( $T_r$ ) is the time between photo detector output intensity changed from 10% to 90%. And fall time ( $T_f$ ) is the time between photo detector output intensity changed from 90% to 10%.

RT = RT (5)

RT (X) is corresponding to the Response Time of the point X at Figure in Note (6).

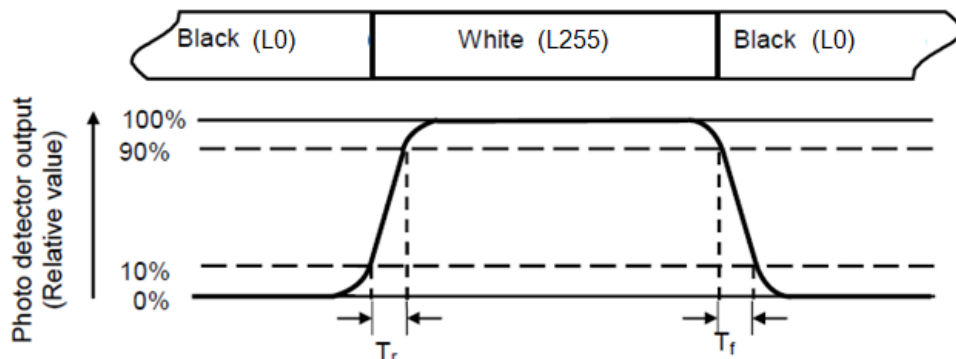

Note (4) Definition of Luminance of White ( $L_c$ ):

Measure the luminance of gray level 255 at center point

LC = L (5)

L (x) is corresponding to the luminance of the point X at Figure in Note (6).

Note (5) Measurement Setup:

The LCD module should be stabilized at given temperature for 40 minutes to avoid abrupt temperature change during measuring. In order to stabilize the luminance, the measurement should be executed after lighting Backlight for 40 minutes in a windless room.

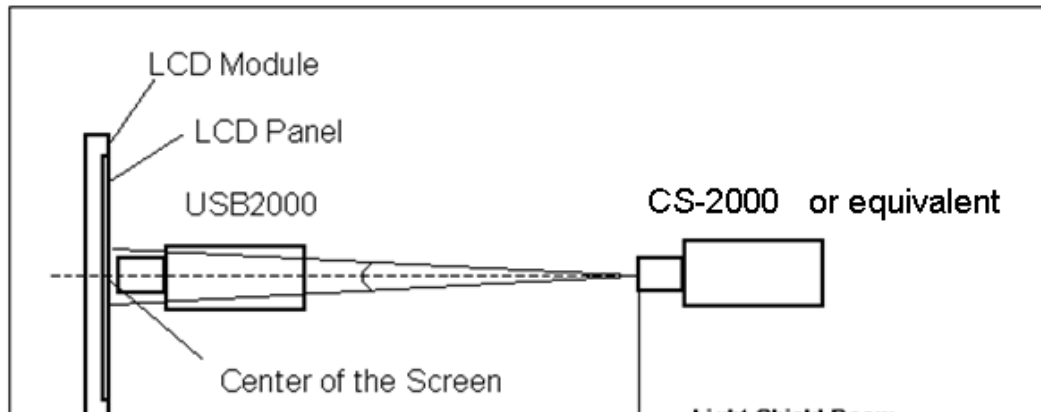

Note (6) Definition of White Variation ( $_W$ ):

Measure the luminance of gray level 255 at 9 points

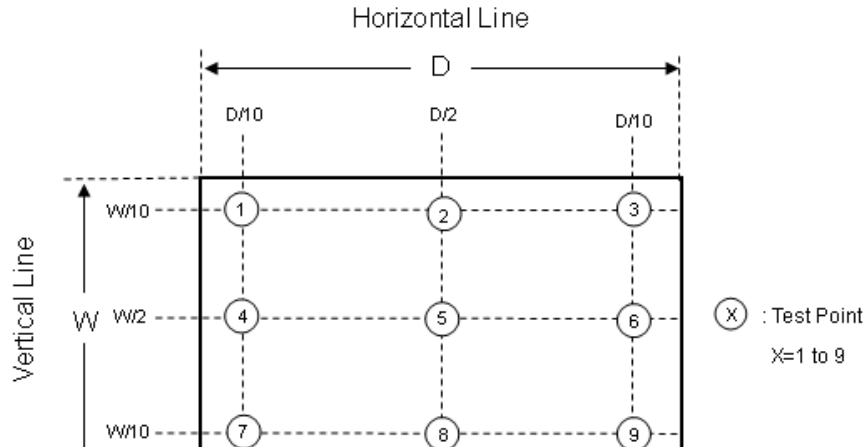

Note (7) The listed optical specifications refer to the initial value of manufacture, but the condition of the specifications after long-term operation will not be warranted.

Note (8) Definition of color gamut (C.G%):

$$C.G\% = \frac{R G B}{R_0 G_0 B_0} * 100\%$$

$R_0, G_0, B_0$ : color coordinates of red, green, and blue defined by NTSC, respectively.

$R, G, B$ : color coordinates of module on 255 gray levels of red, green, and blue, respectively.

$R_0 G_0 B_0$ : area of triangle defined by  $R_0, G_0, B_0$

$R G B$ : area of triangle defined by  $R, G, B$

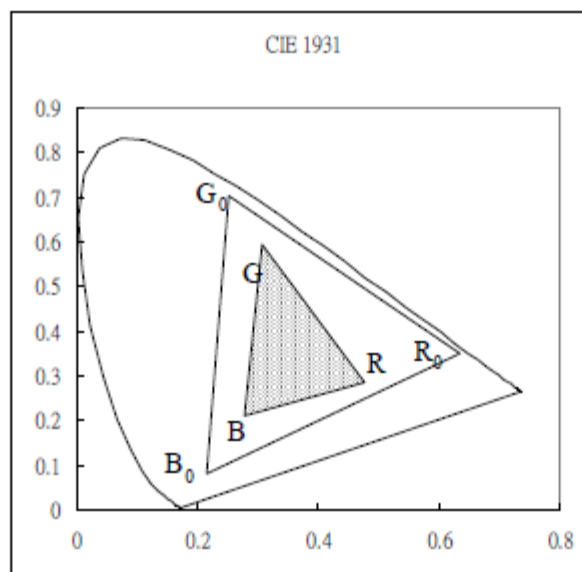





## 8. QUALITY ASSURANCE

No.	Test Items	Test Condition	Note
1	High Temperature Storage	80°C, 240hrs	Note 1, 2
2	Low Temperature Storage	-30°C, 240hrs	Note 1, 2
3	High Temperature Operation	70°C, 240hrs	Note 1, 2
4	Low Temperature Operation	-20°C, 240hrs	Note 1, 2
5	High Temperature and High Humidity Storage	60°C, 90%RH, 240hrs	Note 1, 2
6	Thermal Shock	-20°C/0.5h ~ +70°C/0.5h for a total 100 cycles	Note 1, 2
7	Electro Static Discharge	C=150pF,R=330Ω, 5point/panel Air:±4Kv, 5times	Note 2
8	Package Drop Test	Drop in 1 corner,3 edges,6 surfaces, 1 time/direction Height follow ISTA(1A) 0kg ≤ W < 10kg : 76cm, 10kg ≤ W < 19kg : 61cm, 19kg ≤ W < 28kg : 46cm, 28kg ≤ W < 45kg : 31cm, 45kg ≤ W ≤ 68kg : 20cm	Note 2

Note 1: The test samples have recovery time for 2 hours at room temperature before the function check. In the standard conditions, there is no display function NG issue occurred.

Note 2: After the reliability test, the product only guarantees operation, but don't guarantee all of the cosmetic specification.



## 9. PRECAUTIONS

### 9.1 ESD (Electrical Static Discharge) strategy

- [ 1 ] ESD will cause serious damage of the panel, ESD strategy is very important in handling. Following items are the recommended ESD strategy
- [ 2 ] In handling LCD panel, please wear gloves with non-charged material. Using the conduction ring connects wrist to the earth and the conducting shoes to the earth necessary is.
- [ 3 ] The machine and working table for the panel should have ESD protection strategy.
- [ 4 ] In handling the panel, ionized airflow decreases the charge in the environment is necessary.
- [ 5 ] In the process of assemble module, shield case should connect to the ground.

### 9.2 Environment

- [ 1 ] Working environment of the panel should be in the clean room.
- [ 2 ] Because touch panel has protective film on the surface, please remove the protection film slowly with ionized air to prevent the electrostatic discharge.

### 9.3 Assembly and handling precautions

- [ 1 ] Do not apply improper or unbalanced force such as bending or twisting to open cells during assembly.
- [ 2 ] It is recommended to assemble or to install an open cell into a customer's product in clean working areas. The dust and oil may cause electrical short to an open cell or worsen polarizers on an open cell.
- [ 3 ] Do not apply pressure or impulse to an open cell to prevent the damage.
- [ 4 ] Always follow the correct power-on sequence when an open cell is assembled and turned on. This can prevent the damage and latch-up of the CMOS LSI chips.
- [ 5 ] Do not design sharp-pointed structure / parting line / tooling gate on the plastic part of a COF (Chip on film), because the burr will scrape the COF.
- [ 6 ] If COF would be bended in assemble process, do not place IC on the bending corner.
- [ 7 ] The gap between COF IC and any structure of BLU must be bigger than 2 mm. This can prevent the damage of COF IC.
- [ 8 ] The bezel opening must have no burr and be smooth to prevent the surface of an open cell scraped.
- [ 9 ] The bezel of a module or a TV set can not contact with force on the surface of an open cell. It might cause light leakage or scrape.
- [ 10 ] In the case of no FFC or FPC attached with open cells, customers can refer the FFC / FPC drawing and buy them by self.
- [ 11 ] It is important to keep enough clearance between customers' front bezel/backlight and an open cell. Without enough clearance, the unexpected force during module



- [ 12 ] Do not plug in or unplug an I/F (interface) connector while an assembled open cell is in operation.
- [ 13 ] Use a soft dry cloth without chemicals for cleaning, because the surface of the polarizer is very soft and easily scratched.
- [ 14 ] Moisture can easily penetrate into an open cell and may cause the damage during operation.
- [ 15 ] When storing open cells as spares for a long time, the following precaution is necessary.
  - [ 15.1 ] Do not leave open cells in high temperature and high humidity for a long time. It is highly recommended to store open cells in the temperature range from 0 to 35°C at normal humidity without condensation.
  - [ 15.2 ] Open cells shall be stored in dark place. Do not store open cells in direct sunlight or fluorescent light environment.
- [ 16 ] When ambient temperature is lower than 10°C, the display quality might be reduced.
- [ 17 ] Unpacking (Cartons/Tray plates) in order to prevent open cells broken:
  - [ 17.1 ] Moving tray plates by one operator may cause tray plates bent which may induce open cells broken. Two operators carry one carton with their two hands. Do not throw cartons/tray plates, avoid any impact on cartons/tray plates, and put down & pile cartons/tray plates gently.
  - [ 17.2 ] A tray plate handled with unbalanced force may cause an open cell damaged. Trays should be completely put on a flat platform.
  - [ 17.3 ] To prevent open cells broken, tray plates should be moved one by one from a plastic bag.
  - [ 17.4 ] Please follow the packing design instruction, such as the maximum number of tray stacking to prevent the deformation of tray plates which may cause open cells broken.
  - [ 17.5 ] To prevent an open cell broken or a COF damaged on a tray, please follow the instructions below:
    - [17.5.1] Do not peel a polarizer protection film of an open cell off on a tray
    - [17.5.2] Do not install FFC or LVDS cables of an open cell on a tray
    - [17.5.3] Do not press the surface of an open cell on a tray.
    - [17.5.4] Do not pull X-board when an open cell placed on a tray.
- [ 18 ] Unpacking (Hard Box) in order to prevent open cells broken:
  - [ 18.1 ] Moving hard boxes by one operator may cause hard boxes fell down and open cells broken by abnormal methods. Two operators carry one hard box with their two hands. Do handle hard boxes carefully, such as avoiding impact, putting down, and piling up gently.



- [ 18.2 ] To prevent hard boxes sliding from carts and falling down, hard boxes should be placed on a surface with resistance.
- [ 18.3 ] To prevent an open cell broken or a COF damaged in a hard box, please follow the instructions below:
  - [18.3.1] Do not peel a polarizer protection film of an open cell off in a hard box.
  - [18.3.2] Do not install FFC or LVDS cables of an open cell in a hard box.
  - [18.3.3] Do not press the surface of an open cell in a hard box.
  - [18.3.4] Do not pull X-board when an open cell placed in a hard box.
- [ 19 ] Handling – In order to prevent open cells, COFs , and components damaged:
  - [ 19.1 ] The forced displacement between open cells and X-board may cause a COF damaged. Use a fixture tool for handling an open cell to avoid X-board vibrating and interfering with other components on a PCBA & a COF.
  - [ 19.2 ] To prevent open cells and COFs damaged by taking out from hard boxes, using vacuum jigs to take out open cells horizontally is recommended.
  - [ 19.3 ] Improper installation procedure may cause COFs of an open cell over bent which causes damages. As installing an open cell on a backlight or a test jig, place the bottom side of the open cell first on the backlight or the test jig and make sure no interference before fitting the open cell into the backlight/the test jig.
  - [ 19.4 ] Handle open cells one by one.
- [ 20 ] Avoid any metal or conductive material to contact PCB components, because it could cause electrical damage or defect.

#### 9.4 Safety precautions

- [ 1 ] If the liquid crystal material leaks from the open cell, it should be kept away from the eyes or mouth. In case of contact with hands, skin or clothes, it has to be washed away thoroughly with soap.
- [ 2 ] After the end of life, open cells are not harmful in case of normal operation and storage.

#### 9.5 Others

- [ 1 ] Turn off the power supply before connecting and disconnecting signal input cable.
- [ 2 ] Because the connection area of FPC and panel is not so strong, do not handle panel only by FPC or bend FPC.
- [ 3 ] Water drop on the surface or condensation as panel power on will corrode panel electrode.
- [ 4 ] As the packing bag open, watch out the environment of the panel storage. High temperature and high humidity environment is prohibited.
- [ 5 ] In the case the TFT LCD module is broken, please watch out whether liquid crystal leaks out or not. If your hand touches liquid crystal, wash your hands cleanly with water and soap as soon as possible.



## 11. Packaging Drawing

